

MMUN2211...MMUN2241 NPN Silicon Epitaxial Planar Transistor

for switching and interface circuit and drive circuit applications

Resistor Values

Type	R1 (K)	R2 (K)
MMUN2211	10	10
MMUN2212	22	22
MMUN2213	47	47
MMUN2214	10	47
MMUN2215	10	∞
MMUN2216	4.7	∞
MMUN2230	1	1
MMUN2231	2.2	2.2
MMUN2232	4.7	4.7
MMUN2233	4.7	47
MMUN2234	22	47
MMUN2235	2.2	47
MMUN2238	2.2	∞
MMUN2241	100	∞

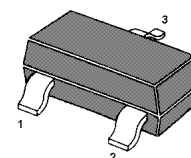

1.Base 2.Emitter 3.Collector
SOT-23 Plastic Package

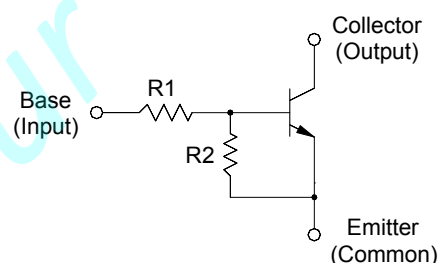

Absolute Maximum Ratings ($T_a = 25\text{ }^\circ\text{C}$)

Parameter	Symbol	Value	Unit
Collector Base Voltage	V_{CBO}	50	V
Collector Emitter Voltage	V_{CEO}	50	V
Collector Current	I_C	100	mA
Total Power Dissipation	P_{tot}	200	mW
Junction Temperature	T_j	150	$^\circ\text{C}$
Storage Temperature Range	T_s	- 55 to + 150	$^\circ\text{C}$

Characteristics at $T_a = 25\text{ }^\circ\text{C}$

Parameter	Symbol	Min.	Max.	Unit	
DC Current Gain at $V_{CE} = 10\text{ V}$, $I_C = 5\text{ mA}$	MMUN2211	h_{FE}	35	-	-
	MMUN2212	h_{FE}	60	-	-
	MMUN2213	h_{FE}	80	-	-
	MMUN2214	h_{FE}	80	-	-
	MMUN2215	h_{FE}	160	-	-
	MMUN2216	h_{FE}	160	-	-
	MMUN2230	h_{FE}	3	-	-
	MMUN2231	h_{FE}	8	-	-
	MMUN2232	h_{FE}	15	-	-
	MMUN2233	h_{FE}	80	-	-
	MMUN2234	h_{FE}	80	-	-
	MMUN2235	h_{FE}	80	-	-
	MMUN2238	h_{FE}	160	-	-
	MMUN2241	h_{FE}	160	-	-
	Collector Base Cutoff Current at $V_{CB} = 50\text{ V}$	I_{CBO}	-	100	nA
Collector Emitter Cutoff Current at $V_{CE} = 50\text{ V}$	I_{CEO}	-	500	nA	
Emitter Base Cutoff Current at $V_{EB} = 6\text{ V}$	MMUN2211	I_{EBO}	-	0.5	mA
	MMUN2212	I_{EBO}	-	0.2	mA
	MMUN2213	I_{EBO}	-	0.1	mA
	MMUN2214	I_{EBO}	-	0.2	mA
	MMUN2215	I_{EBO}	-	0.9	mA
	MMUN2216	I_{EBO}	-	1.9	mA
	MMUN2230	I_{EBO}	-	4.3	mA
	MMUN2231	I_{EBO}	-	2.3	mA
	MMUN2232	I_{EBO}	-	1.5	mA
	MMUN2233	I_{EBO}	-	0.18	mA
	MMUN2234	I_{EBO}	-	0.13	mA
	MMUN2235	I_{EBO}	-	0.2	mA
	MMUN2238	I_{EBO}	-	4	mA
MMUN2241	I_{EBO}	-	0.1	mA	
Collector Base Breakdown Voltage at $I_C = 10\text{ }\mu\text{A}$	$V_{(BR)CBO}$	50	-	V	
Collector Emitter Breakdown Voltage at $I_C = 2\text{ mA}$	$V_{(BR)CEO}$	50	-	V	
Collector Emitter Saturation Voltage at $I_C = 10\text{ mA}$, $I_B = 0.3\text{ mA}$ at $I_C = 10\text{ mA}$, $I_B = 5\text{ mA}$ at $I_C = 10\text{ mA}$, $I_B = 1\text{ mA}$		V_{CEsat}	-	0.25	V
	MMUN2230	V_{CEsat}	-	0.25	V
	MMUN2231	V_{CEsat}	-	0.25	V
	MMUN2215	V_{CEsat}	-	0.25	V
	MMUN2216	V_{CEsat}	-	0.25	V
	MMUN2232	V_{CEsat}	-	0.25	V
	MMUN2233	V_{CEsat}	-	0.25	V
	MMUN2234	V_{CEsat}	-	0.25	V
	MMUN2235	V_{CEsat}	-	0.25	V
	MMUN2238	V_{CEsat}	-	0.25	V

Characteristics at $T_a = 25\text{ }^\circ\text{C}$

Parameter	Symbol	Min.	Max.	Unit		
Output Voltage (on) at $V_{CC} = 5\text{ V}$, $V_B = 2.5\text{ V}$, $R_L = 1\text{ K}\Omega$	MMUN2211	V_{OL}	-	0.2	V	
	MMUN2212	V_{OL}	-	0.2	V	
	MMUN2214	V_{OL}	-	0.2	V	
	MMUN2215	V_{OL}	-	0.2	V	
	MMUN2216	V_{OL}	-	0.2	V	
	MMUN2230	V_{OL}	-	0.2	V	
	MMUN2231	V_{OL}	-	0.2	V	
	MMUN2232	V_{OL}	-	0.2	V	
	MMUN2233	V_{OL}	-	0.2	V	
	MMUN2234	V_{OL}	-	0.2	V	
	MMUN2235	V_{OL}	-	0.2	V	
	MMUN2238	V_{OL}	-	0.2	V	
	at $V_{CC} = 5\text{ V}$, $V_B = 3.5\text{ V}$, $R_L = 1\text{ K}\Omega$	MMUN2213	V_{OL}	-	0.2	V
	at $V_{CC} = 5\text{ V}$, $V_B = 5\text{ V}$, $R_L = 1\text{ K}\Omega$	MMUN2241	V_{OL}	-	0.2	V
Output Voltage (off) at $V_{CC} = 5\text{ V}$, $V_B = 0.5\text{ V}$, $R_L = 1\text{ K}\Omega$ at $V_{CC} = 5\text{ V}$, $V_B = 0.05\text{ V}$, $R_L = 1\text{ K}\Omega$ at $V_{CC} = 5\text{ V}$, $V_B = 0.25\text{ V}$, $R_L = 1\text{ K}\Omega$	MMUN2230	V_{OH}	4.9	-	V	
	MMUN2215	V_{OH}	4.9	-	V	
	MMUN2216	V_{OH}	4.9	-	V	
	MMUN2233	V_{OH}	4.9	-	V	
	MMUN2238	V_{OH}	4.9	-	V	
	MMUN2238	V_{OH}	4.9	-	V	
Input Resistor	MMUN2211	R1	7	13	K Ω	
	MMUN2212	R1	15.4	28.6	K Ω	
	MMUN2213	R1	32.9	61.1	K Ω	
	MMUN2214	R1	7	13	K Ω	
	MMUN2215	R1	7	13	K Ω	
	MMUN2216	R1	3.3	6.1	K Ω	
	MMUN2230	R1	0.7	1.3	K Ω	
	MMUN2231	R1	1.5	2.9	K Ω	
	MMUN2232	R1	3.3	6.1	K Ω	
	MMUN2233	R1	3.3	6.1	K Ω	
	MMUN2234	R1	15.4	28.6	K Ω	
	MMUN2235	R1	1.54	2.86	K Ω	
	MMUN2238	R1	1.54	2.88	K Ω	
	MMUN2241	R1	70	130	K Ω	
	Resistor Ratio	MMUN2211/MMUN2212/MMUN2213	R1/R2	0.8	1.2	-
MMUN2214		R1/R2	0.17	0.25	-	
MMUN2215/MMUN2216/MMUN2238		R1/R2	-	-	-	
MMUN2241		R1/R2	-	-	-	
MMUN2230/MMUN2231/MMUN2232		R1/R2	0.8	1.2	-	
MMUN2233		R1/R2	0.055	0.185	-	
MMUN2234		R1/R2	0.38	0.56	-	
MMUN2235		R1/R2	0.038	0.056	-	

Typical Characteristics

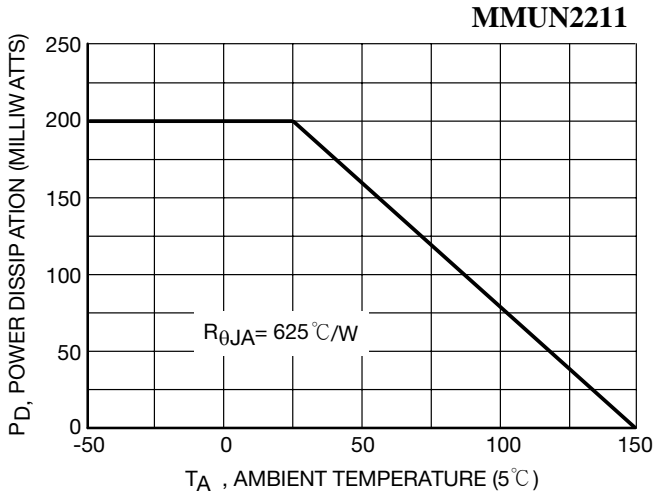

Figure 1. Derating Curve

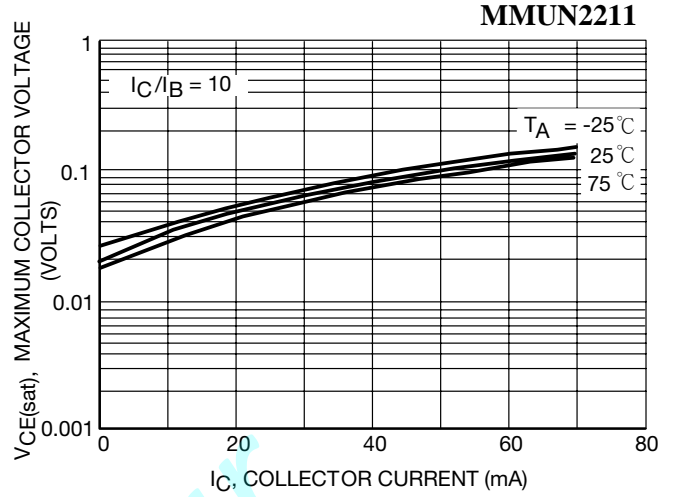

Figure 2. V_{CE(sat)} vs. I_C

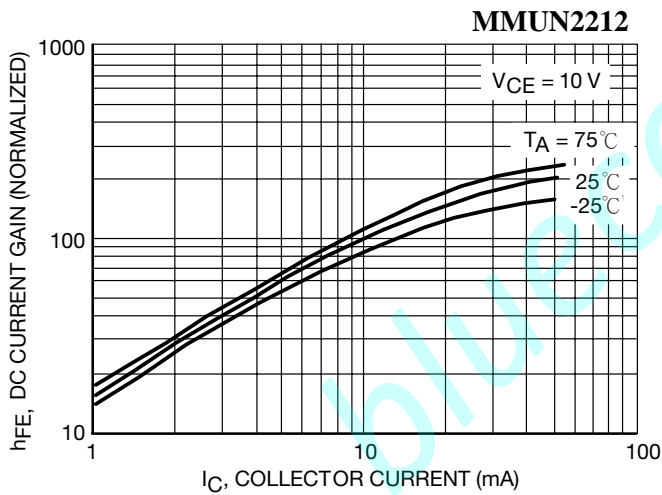

Figure 3. DC Current Gain

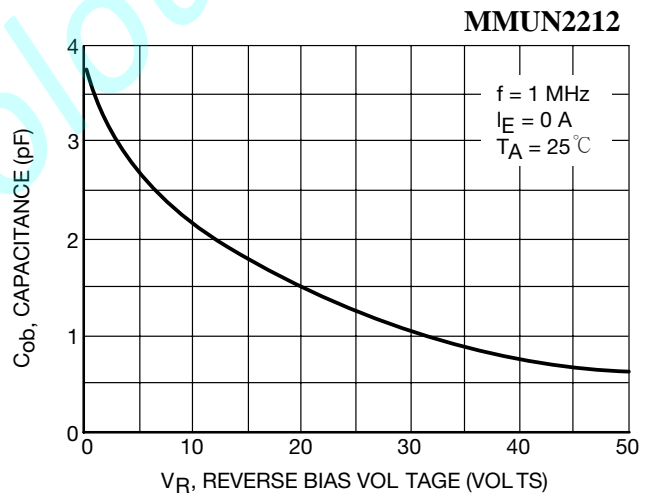

Figure 4. Output Capacitance

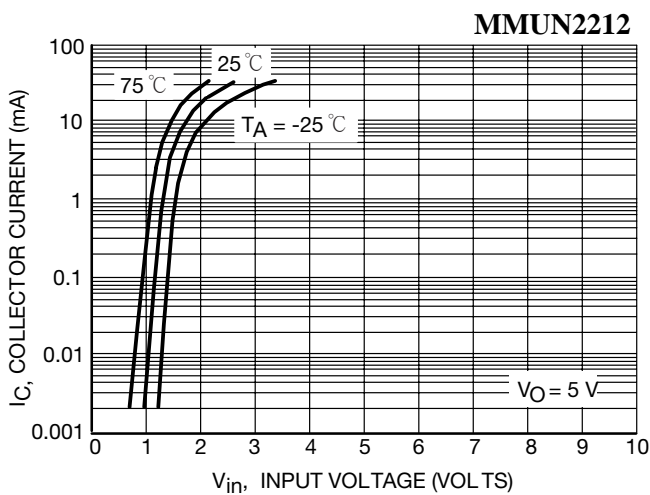

Figure 5. Output Current vs. Input Voltage

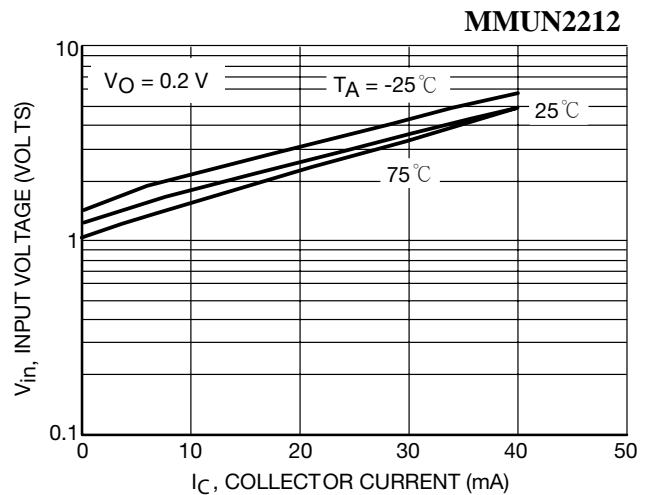

Figure 6. Input Voltage vs. Output Current

Typical Characteristics

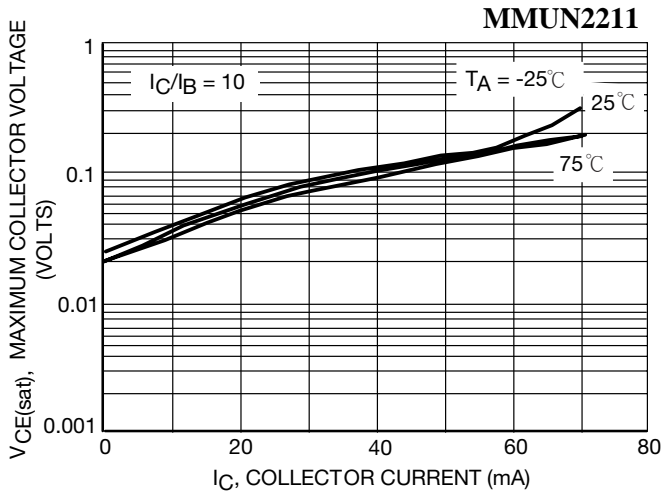

Figure 7. $V_{CE(sat)}$ vs. I_C

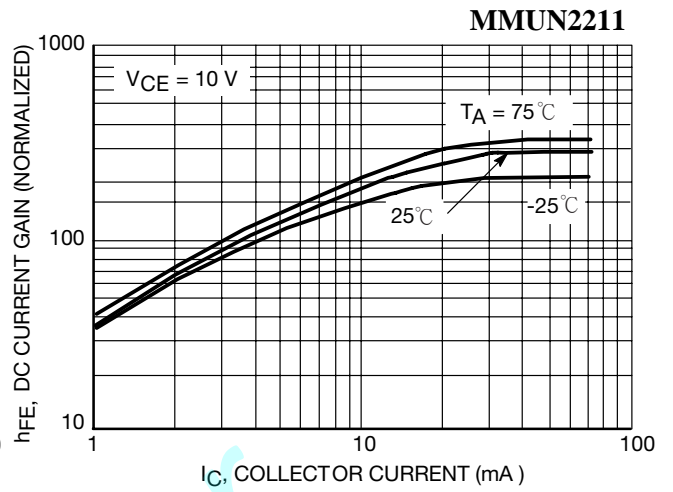

Figure 8. DC Current Gain

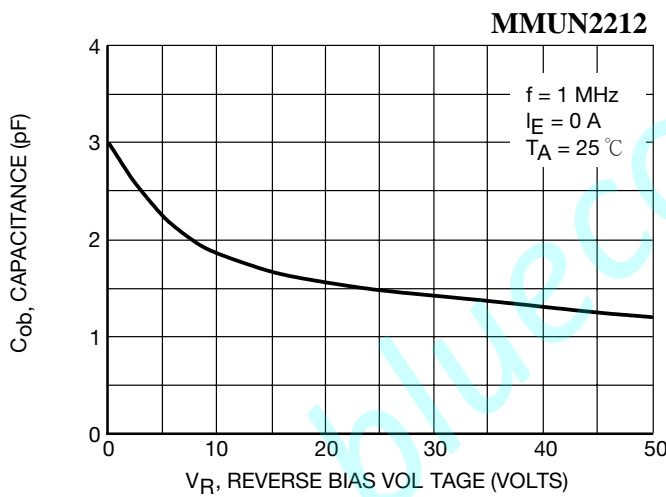

Figure 9. Output Capacitance

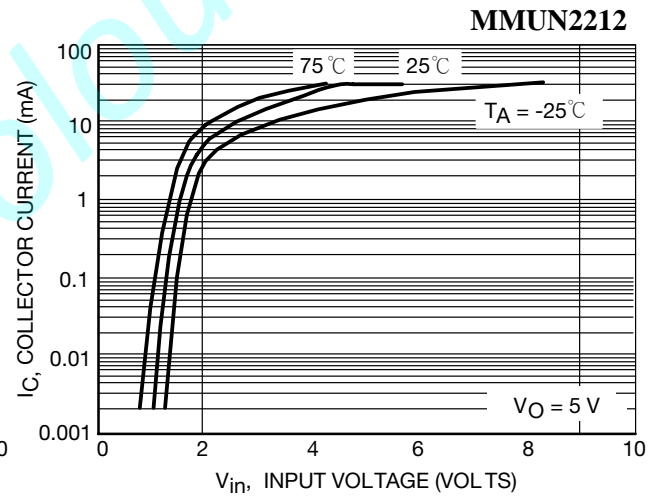

Figure 10. Output Current vs. Input Voltage

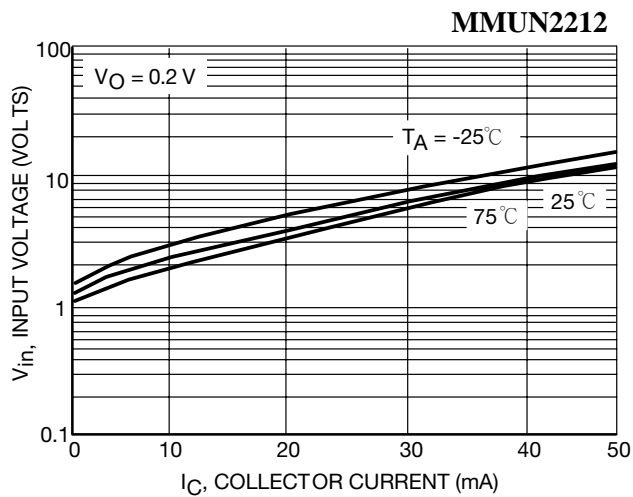

Figure 11. Input Voltage vs. Output Current

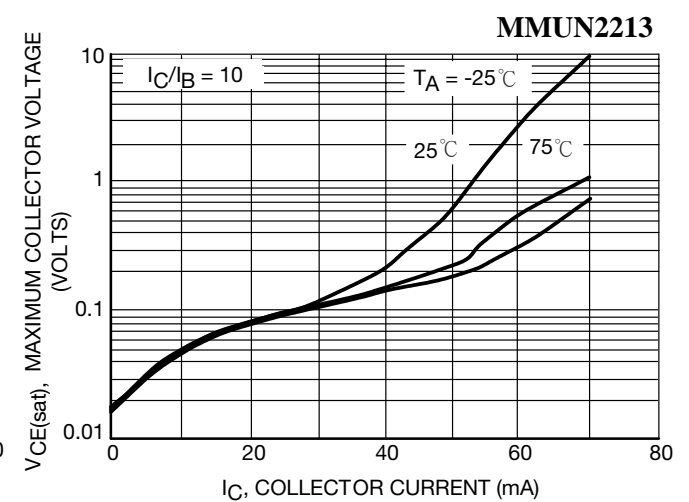

Figure 12. $V_{CE(sat)}$ vs. I_C

Typical Characteristics

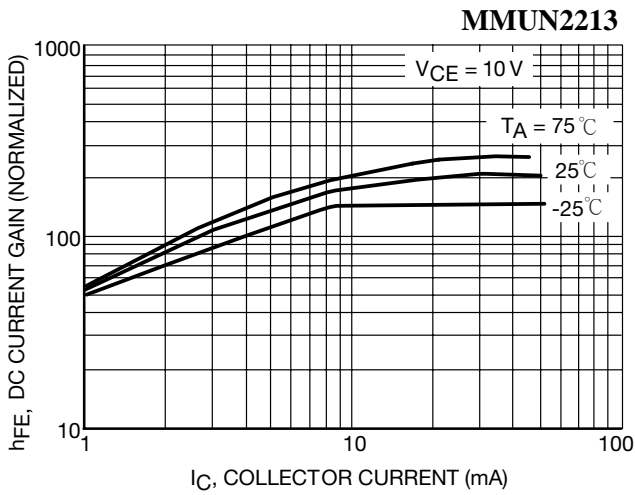

Figure 13. DC Current Gain

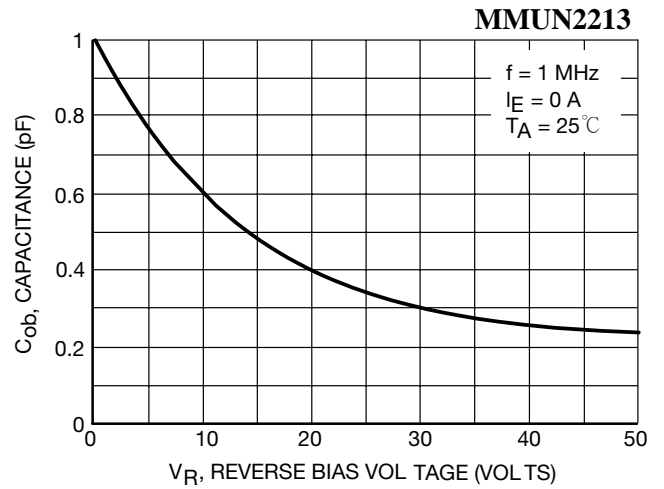

Figure 14. Output Capacitance

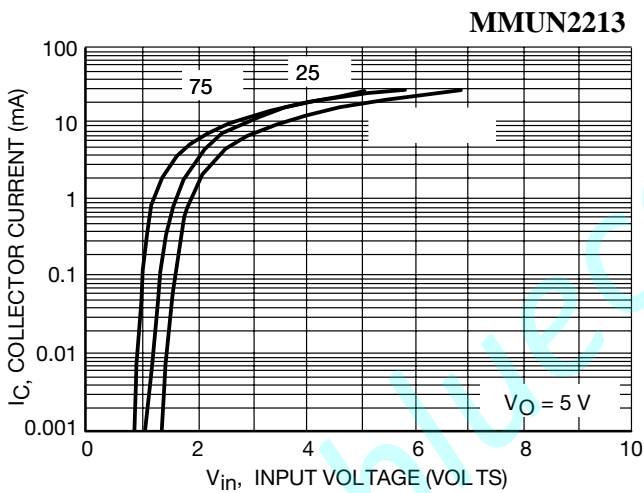

Figure 15. Output Current vs. Input Voltage

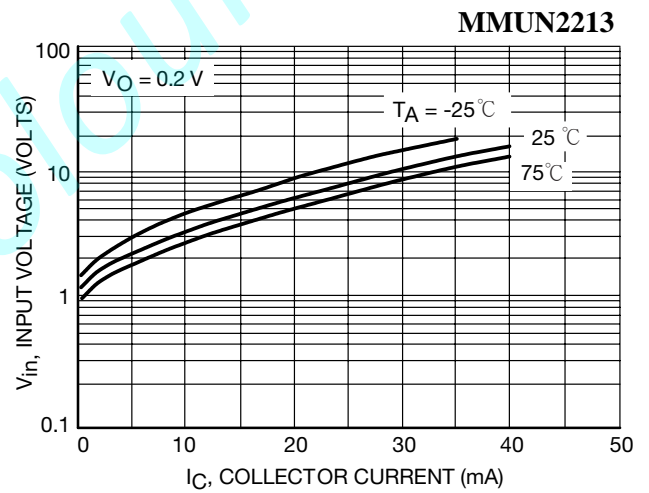

Figure 16. Input Voltage vs. Output Current

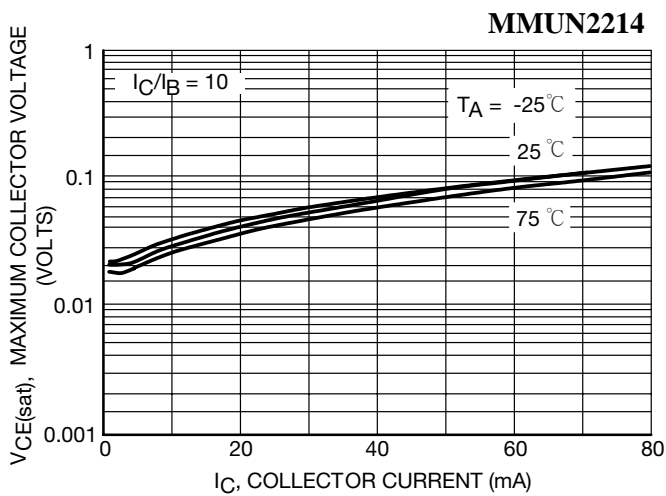

Figure 17. $V_{CE(sat)}$ vs. I_C

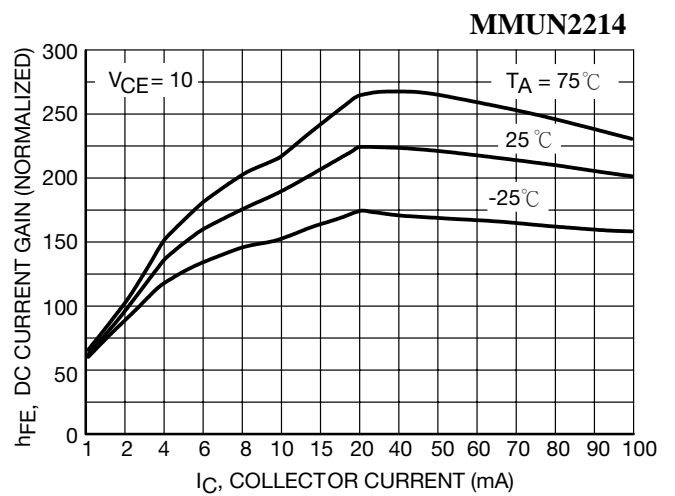

Figure 18. DC Current Gain

Typical Characteristics

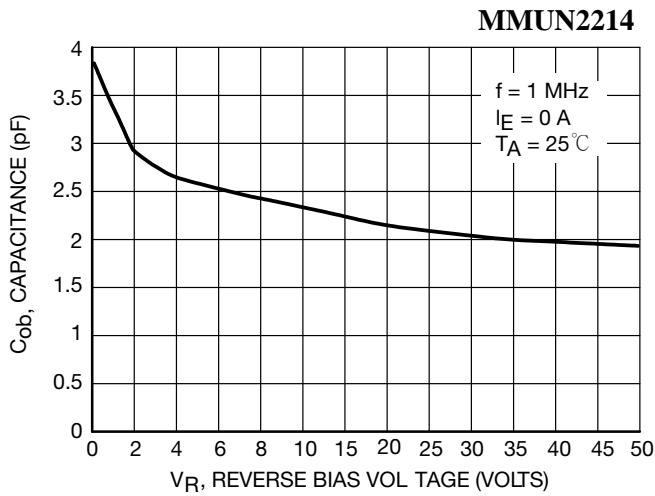

Figure 19. Output Capacitance

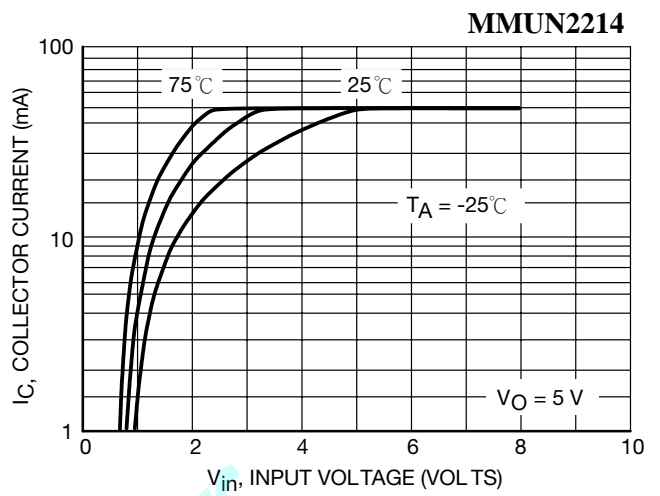

Figure 20. Output Current vs. Input Voltage

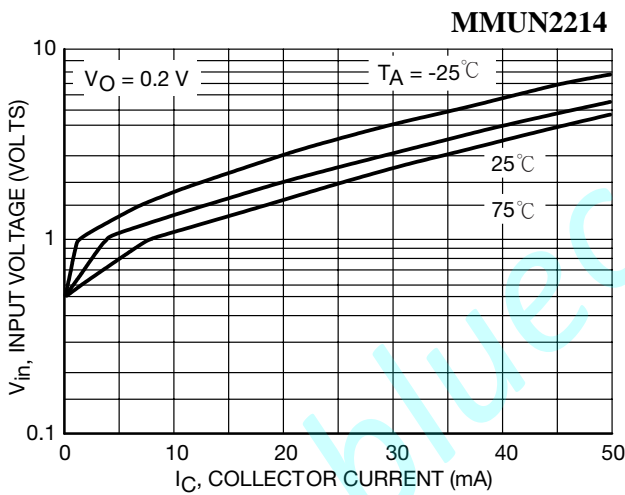

Figure 21. Input Voltage vs. Output Current

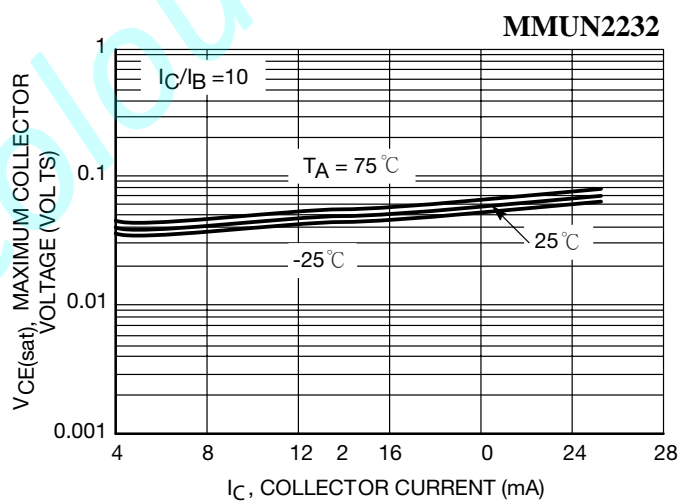

Figure 22. $V_{CE(sat)}$ vs. I_C

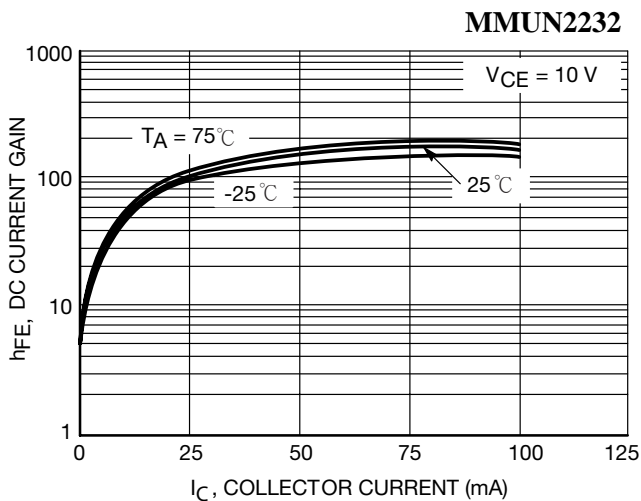

Figure 23. DC Current Gain

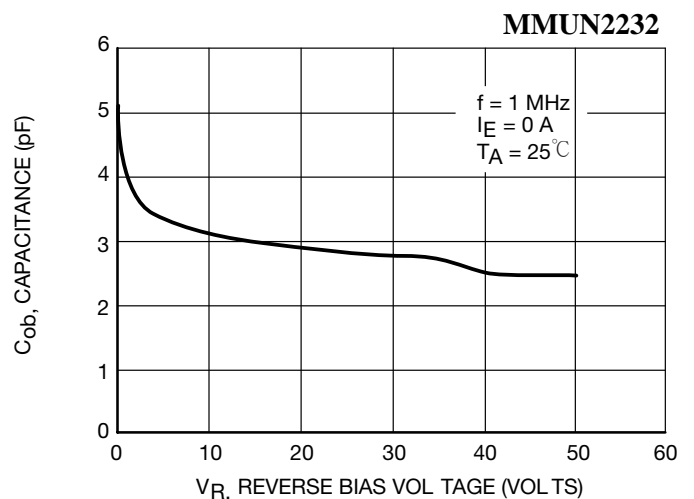

Figure 24. Output Capacitance

Typical Characteristics

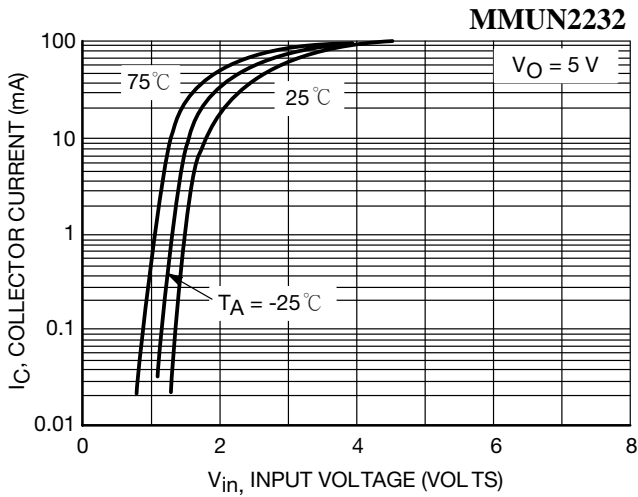

Figure 25. Output Current vs. Input Voltage

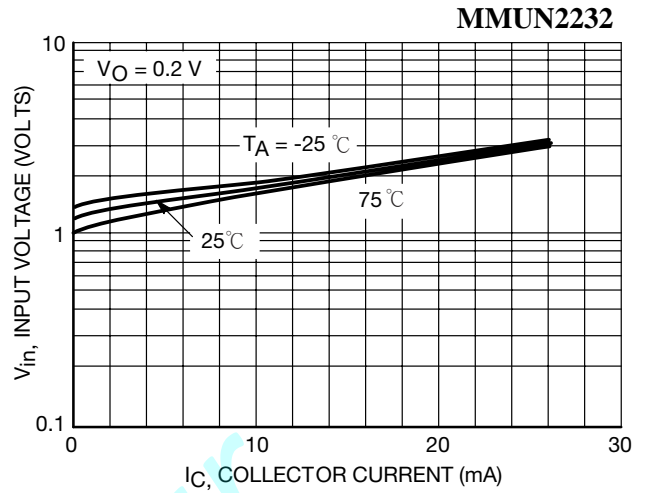

Figure 26. Output Voltage vs. Input Current

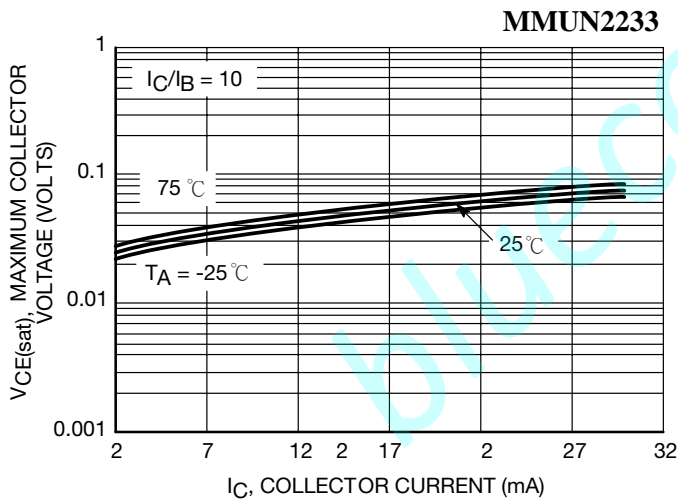

Figure 27. $V_{CE(sat)}$ vs. I_C

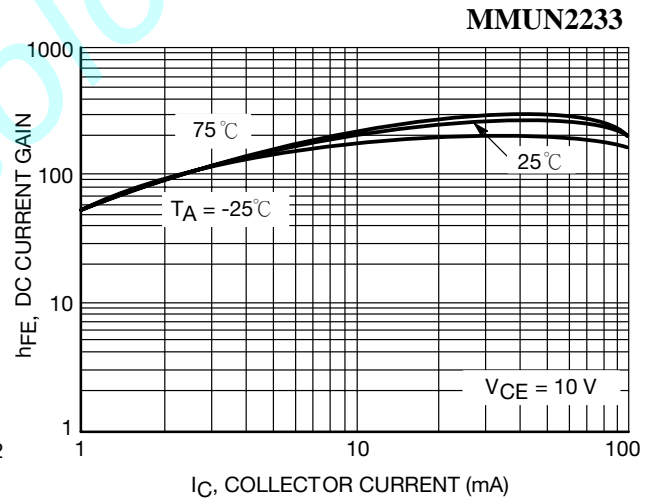

Figure 28. DC Current Gain

MMUN2211 Series

TYPICAL APPLICATIONS FOR NPN BJT's

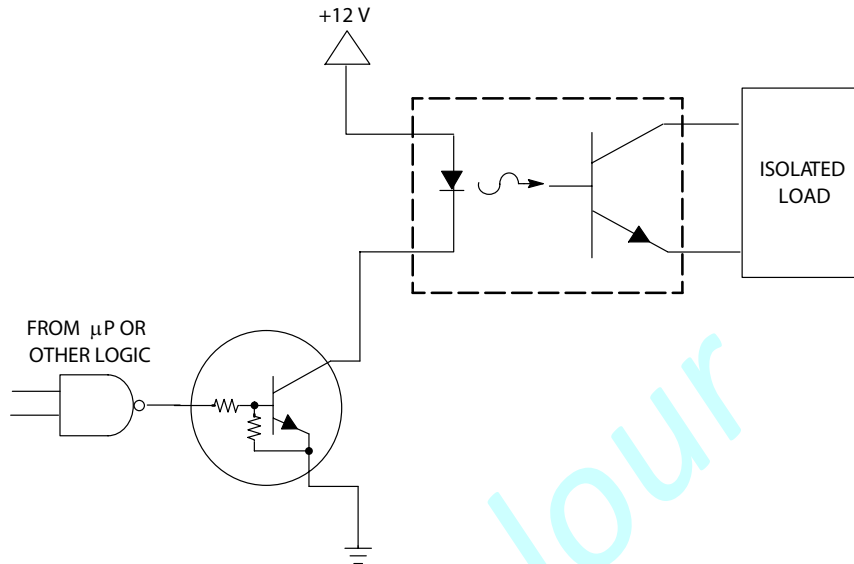

Figure 32. Level Shifter: Connects 12 or 24 Volt Circuits to Logic

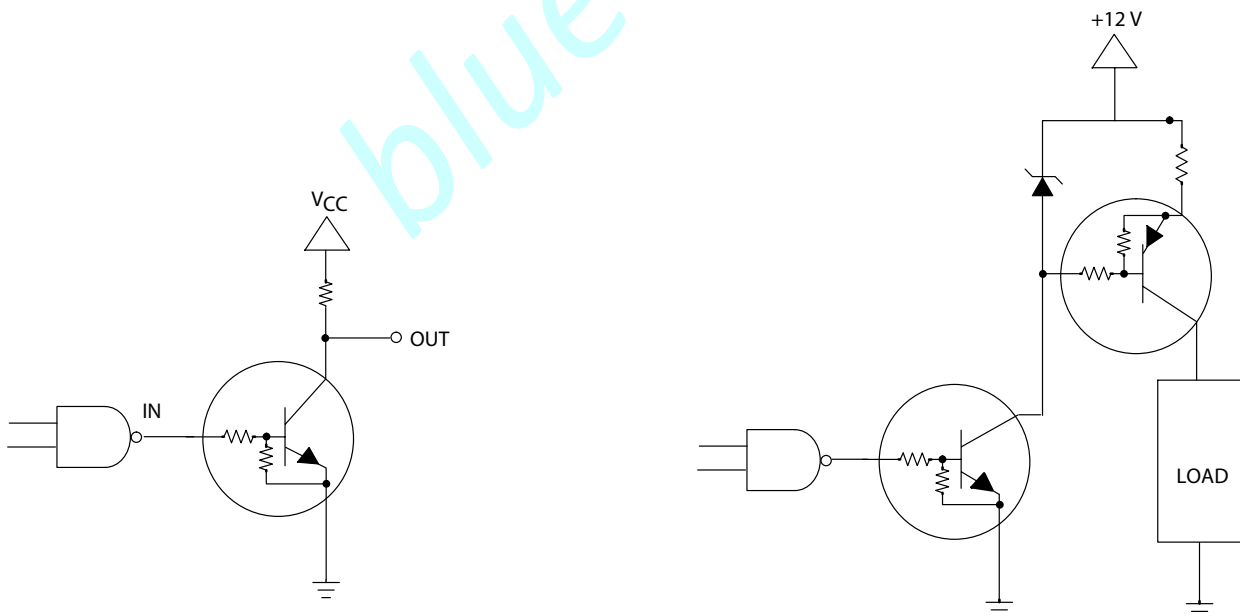

Figure 33. Open Collector Inverter: Inverts the Input Signal

Figure 34. Inexpensive, Unregulated Current Source

PACKAGE OUTLINE

Plastic surface mounted package; 3 leads

SOT-23

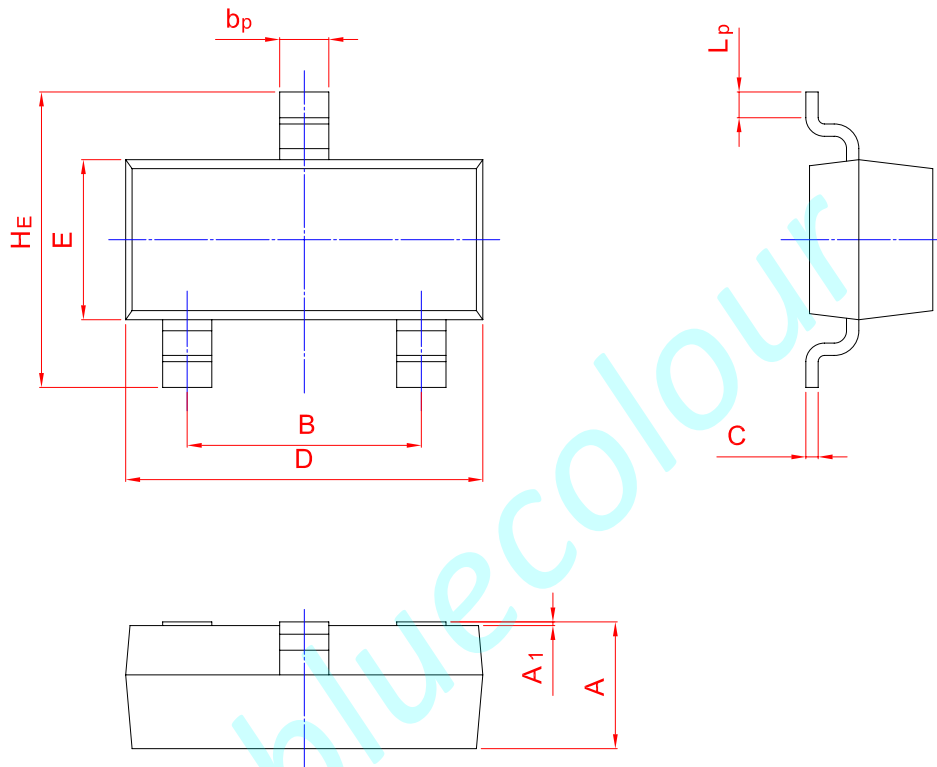
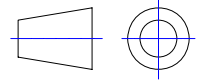

UNIT	A	B	bp	C	D	E	HE	A1	Lp
mm	1.40	2.04	0.50	0.19	3.10	1.65	3.00	0.100	0.50
	0.95	1.78	0.35	0.08	2.70	1.20	2.20	0.013	0.20