

MMBT28S NPN Silicon Epitaxial Planar Transistor

for switching and amplifier applications. Especially suitable for AF-driver stages and low power output stages.

The transistor is subdivided into one group, according to its DC current gain.

On special request, these transistors can be manufactured in different pin configurations.

Marking : 28S

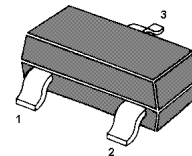

1.Base 2.Emitter 3.Collector
SOT-23 Plastic Package

Absolute Maximum Ratings ($T_a = 25\text{ }^\circ\text{C}$)

Parameter	Symbol	Value	Unit
Collector Base Voltage	V_{CBO}	40	V
Collector Emitter Voltage	V_{CEO}	20	V
Emitter Base Voltage	V_{EBO}	6	V
Collector Current	I_C	1	A
Peak Collector Current	I_{CM}	1.25	A
Base Current	I_B	100	mA
Power Dissipation	P_{tot}	200	mW
Junction Temperature	T_j	150	$^\circ\text{C}$
Storage Temperature Range	T_S	-55 to +150	$^\circ\text{C}$

ELECTRICAL CHARACTERISTICS (Tamb=25 unless otherwise specified)

Parameter	Symbol	Min.	Max.	Unit
DC Current Gain				
at $V_{CE}=1V, I_C=5mA$	h_{FE}	45	-	-
at $V_{CE}=1V, I_C=100mA$	h_{FE}	200	1000	-
at $V_{CE}=1V, I_C=800mA$	h_{FE}	40	-	-
Collector Base Breakdown Voltage				
at $I_C=100\mu A$	$V_{(BR)CBO}$	40	-	V
Collector Emitter Breakdown Voltage				
at $I_C=2mA$	$V_{(BR)CEO}$	20	-	V
Emitter Base Breakdown Voltage				
at $I_E=100\mu A$	$V_{(BR)EBO}$	6	-	V
Collector Cutoff Current				
at $V_{CB}=35V$	I_{CBO}	-	100	nA
Emitter Cutoff Current				
at $V_{BE}=6V$	I_{EBO}	-	100	nA
Collector Saturation Voltage				
at $I_C=600mA, I_B=20mA$	$V_{CE(sat)}$	-	0.55	V
Base Saturation Voltage				
at $I_C=600mA, I_B=20mA$	$V_{BE(sat)}$	-	1.2	V
Base Emitter Voltage				
at $I_C=10mA, V_{CE}=1V$	V_{BE}	-	1.0	V
Gain Bandwidth Product				
at $V_{CE}=10V, I_C=50mA$	f_T	100	-	MHz
Collector Base Capacitance				
at $V_{CB}=10V, f=1MHz$	C_{OB}	-	9	pF

Typical Characteristics

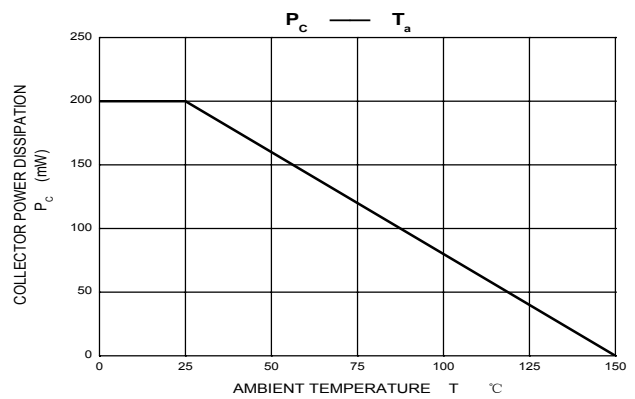
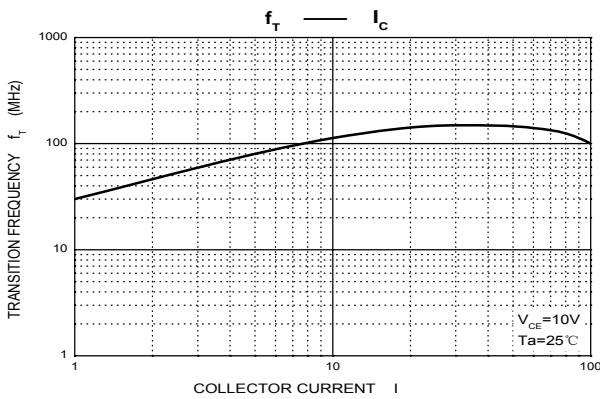
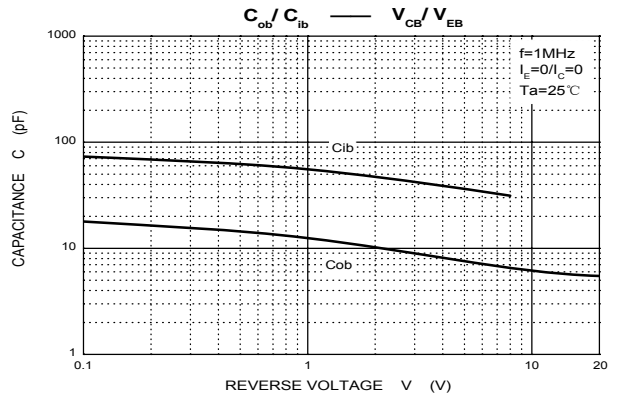
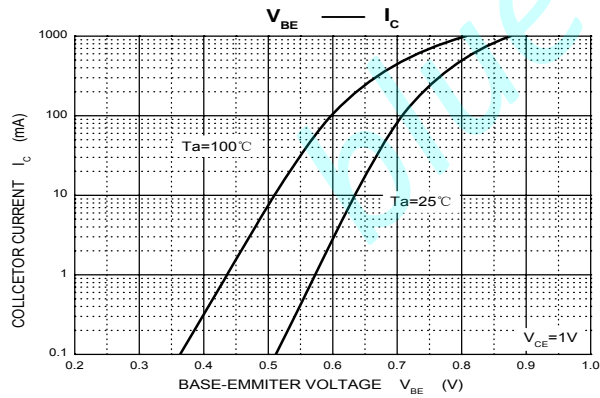
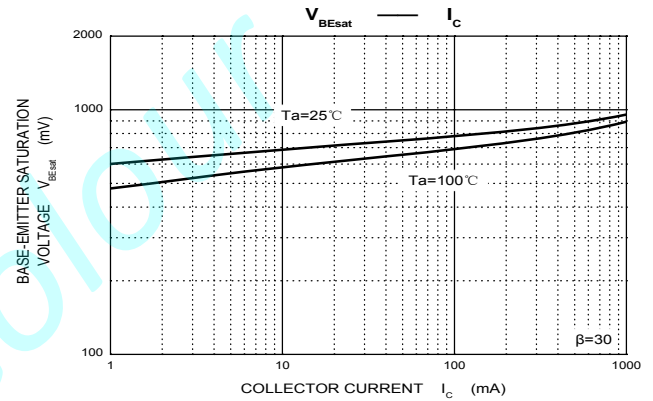
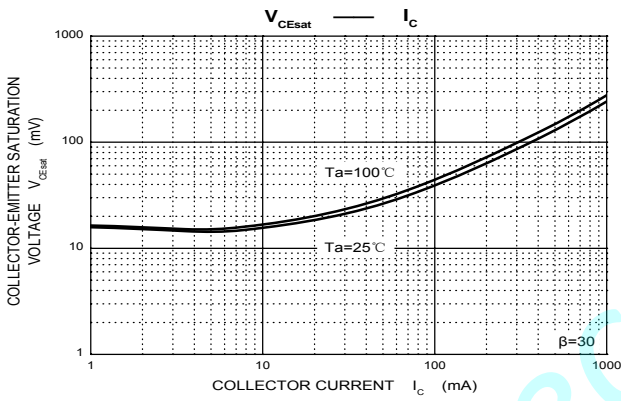
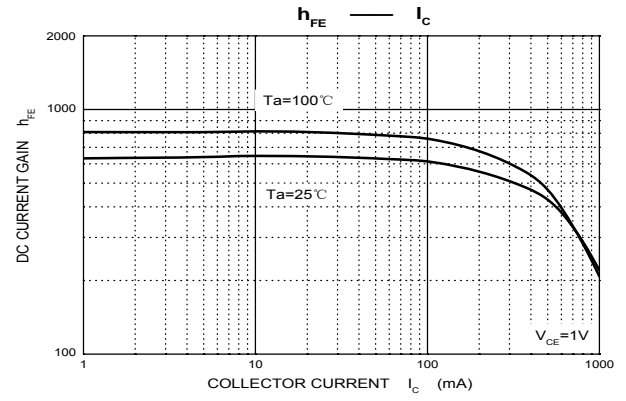
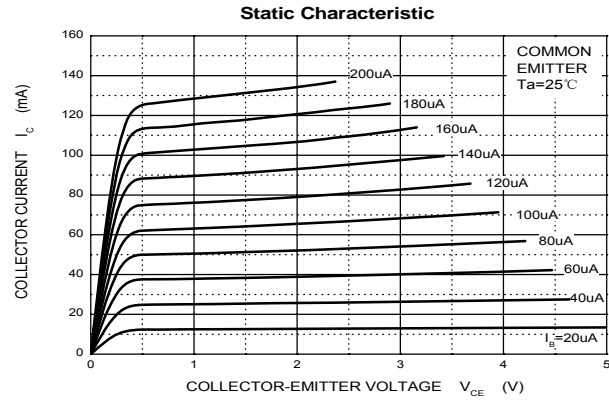

PACKAGE OUTLINE

Plastic surface mounted package; 3 leads

SOT-23

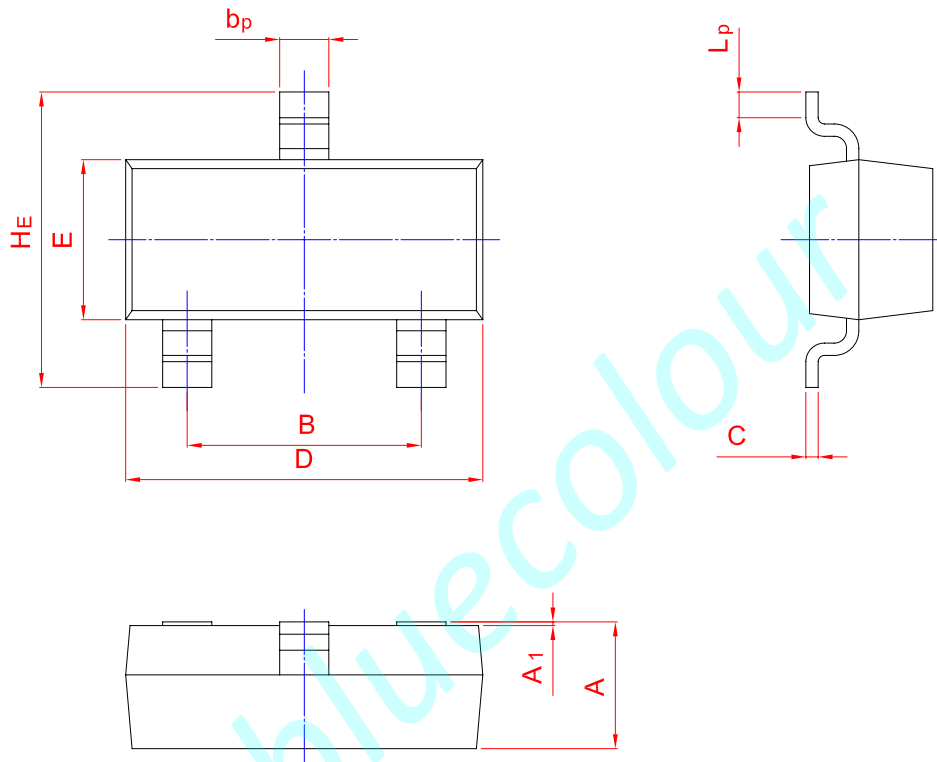
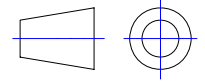

UNIT	A	B	bp	C	D	E	HE	A1	Lp
mm	1.40	2.04	0.50	0.19	3.10	1.65	3.00	0.100	0.50
	0.95	1.78	0.35	0.08	2.70	1.20	2.20	0.013	0.20