

DTC143XCA DIGITAL TRANSISTOR(NPN)

FEATURES

- Built-in bias resistors enable the configuration of an inverter circuit without connecting external input resistors(see equivalent circuit)
- The bias resistors consist of thin-film resistors with complete isolation to allow negative biasing of the input.They also have the advantage of almost completely eliminating parasitic effects
- Only the on/off conditions need to be set for operation, making device design easy

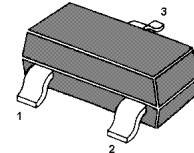

1.Base (IN) 2.Emitter (GND)
3.Collector (OUT)
SOT-23 Plastic Package

MARKING: X43

MAXIMUM RATINGS(Ta=25°C unless otherwise noted)

Symbol	Parameter	Limits	Unit
V _{CC}	Supply Voltage	50	V
V _{IN}	Input Voltage	-7~+20	V
I _O	Output Current	100	mA
P _D	Power Dissipation	200	mW
T _J	Junction Temperature	150	°C
T _{stg}	Storage Temperature	-55~+150	°C

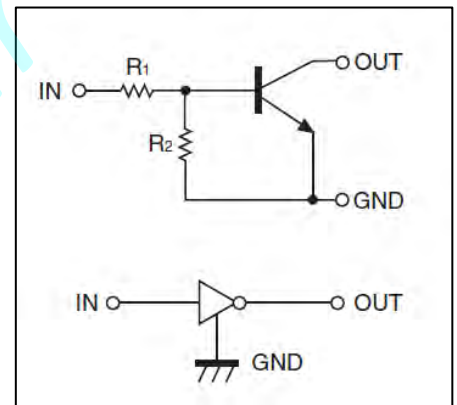

Equivalent Circuit

ELECTRICAL CHARACTERISTICS (Ta=25°C unless otherwise specified)

Parameter	Symbol	Conditions	Min	Typ	Max	Unit
Input voltage	V _{I(off)}	V _{CC} =5V, I _O =100μA	0.3			V
	V _{I(on)}	V _O =0.3V, I _O =20mA			2.5	V
Output voltage	V _{O(on)}	I _O /I _I =10mA/0.5mA		0.1	0.3	V
Input current	I _I	V _I =5V			1.8	mA
Output current	I _{O(off)}	V _{CC} =50V, V _I =0			0.5	μA
DC current gain	G _I	V _O =5V, I _O =10mA	30			
Input resistance	R _I		3.29	4.7	6.11	kΩ
Resistance ratio	R ₂ /R ₁		1.7	2.1	2.6	
Transition frequency	f _T	V _O =10V, I _O =5mA, f=100MHz		250		MHz

Typical Characteristics

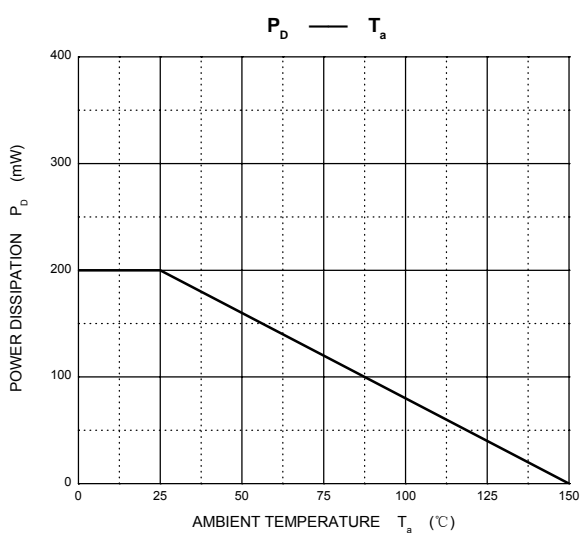
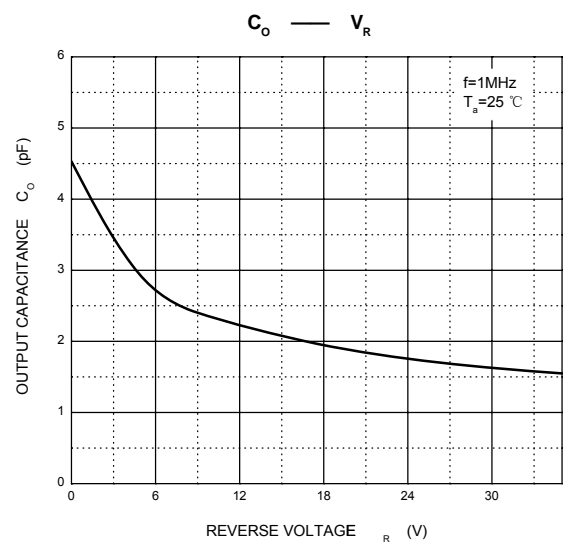
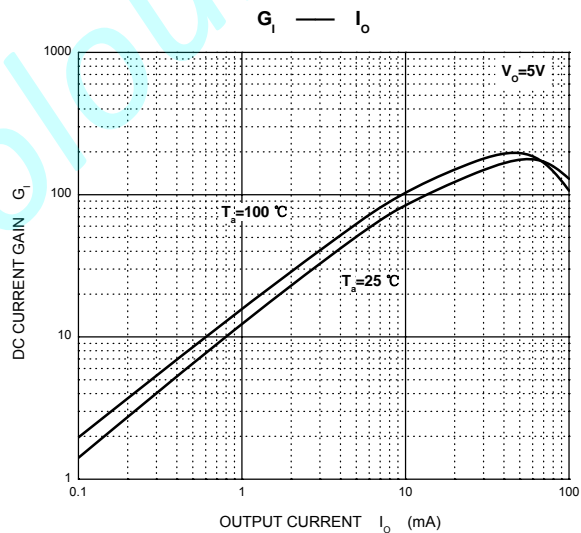
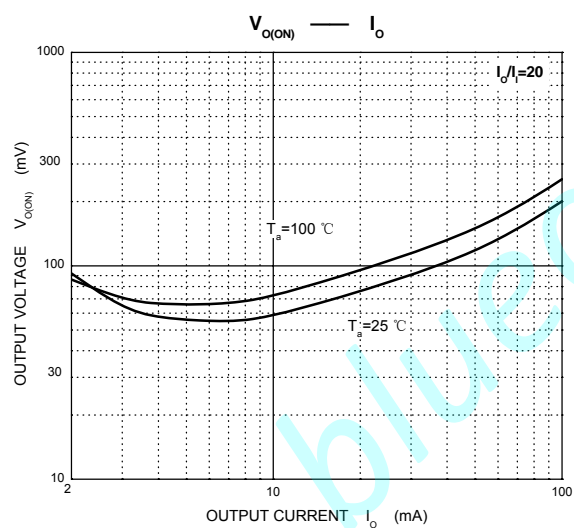
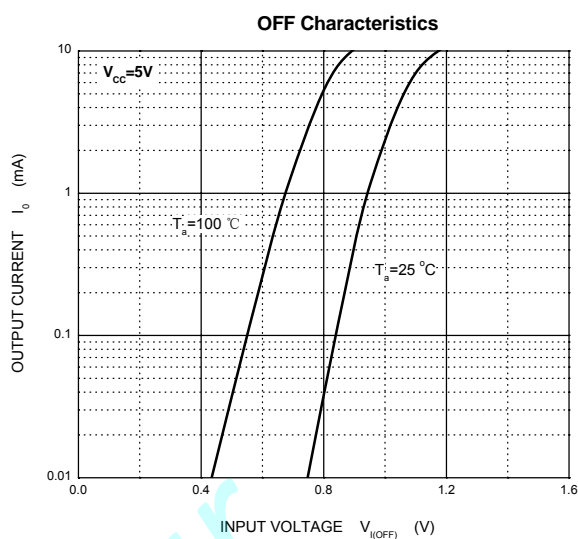
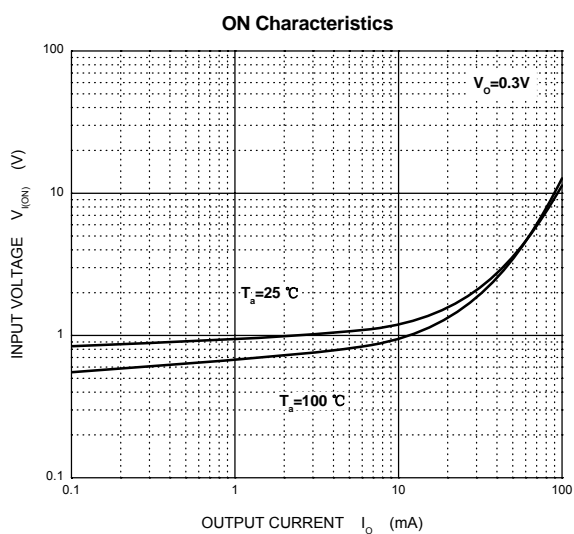

PACKAGE OUTLINE

Plastic surface mounted package; 3 leads

SOT-23



UNIT	A	B	bp	C	D	E	HE	A1	Lp
mm	1.40	2.04	0.50	0.19	3.10	1.65	3.00	0.100	0.50
	0.95	1.78	0.35	0.08	2.70	1.20	2.20	0.013	0.20